



■ Vers. 064



■ Vers. 064







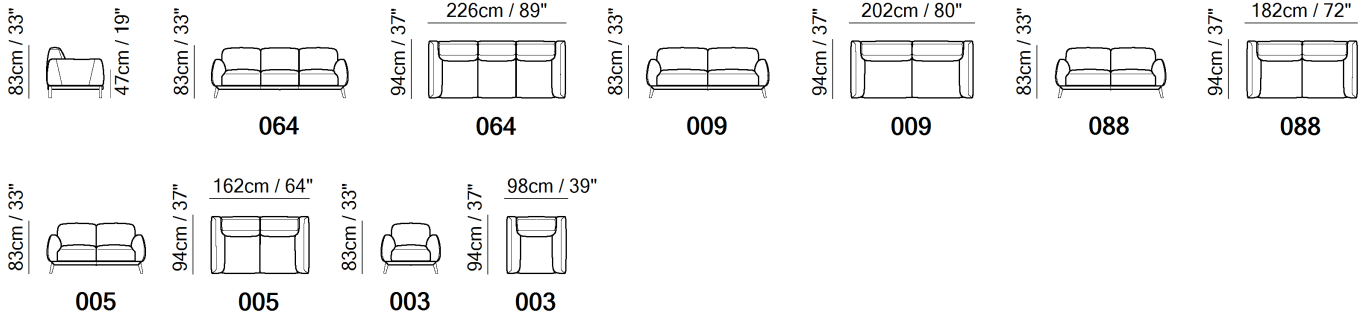

■ Vers. 003

SCHEMATICS



TECHNICAL INFORMATION

	<b>COVERING</b>	Leather <input checked="" type="checkbox"/>	Soft Cover <input checked="" type="checkbox"/>			
	<b>LEGS</b>	Wood <input checked="" type="checkbox"/>	Metal <input type="checkbox"/>	Plastic <input type="checkbox"/>	Castors <input type="checkbox"/>	Upholstered <input type="checkbox"/>
	<b>FILLING</b>	Arms <input type="checkbox"/> Fiber <input checked="" type="checkbox"/> Foam <input type="checkbox"/> Feather/Fiber Mix <input type="checkbox"/> Feather	Seat cushion <input type="checkbox"/> Fiber <input checked="" type="checkbox"/> Foam <input type="checkbox"/> Feather/Fiber Mix <input type="checkbox"/> Feather	Back cushion <input type="checkbox"/> Fiber <input checked="" type="checkbox"/> Foam <input type="checkbox"/> Feather/Fiber Mix <input type="checkbox"/> Feather		
	<b>COMFORT</b>	Standard Comfort <input checked="" type="checkbox"/>	Firm Comfort <input type="checkbox"/>			
	<b>FUNCTION</b>	Bed <input type="checkbox"/>	Electric motion <input type="checkbox"/>	Motion <input type="checkbox"/>	Recliner <input type="checkbox"/>	Sliding <input type="checkbox"/>
	<b>OPTIONS</b>	Nails <input type="checkbox"/>	Contrast Stitching <input type="checkbox"/>	Removable <input type="checkbox"/>		
	<b>WRINKLES &amp; VISUAL APPEARANCE</b>	Low <input checked="" type="checkbox"/>	Medium <input type="checkbox"/>	High <input type="checkbox"/>		

WRINKLES & VISUAL APPEARANCE

Due to a combination of the elasticity of the covering, the nature of the interior construction and the design for comfortability of the product, the model may exhibit differing levels of wrinkles.



The models need to be dressed on a regular basis to maintain their appearance and the wrinkles should not be considered as a manufacturing defect, but a natural characteristic of the product.

NOTES

- Available in leather (TG only) or fabric.
- Feet available in wood finishings 09 (Walnut) / 18 (Wengè)

NOTES

---